

# VIKI TYP2

Art.-Nr.

396 074  
396 077  
396 078

700  
1200  
284  
[ mm ]

1/4  
VO  
23-2024

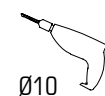
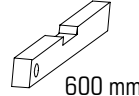
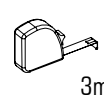
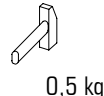
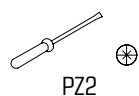
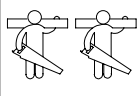

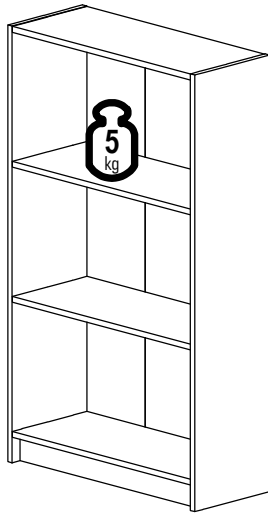
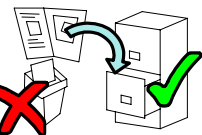
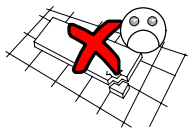
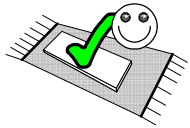
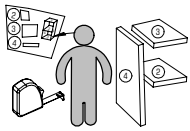
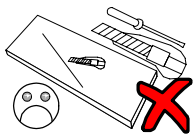
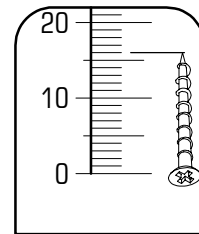
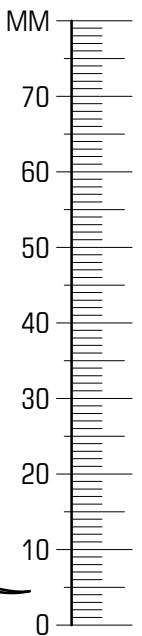
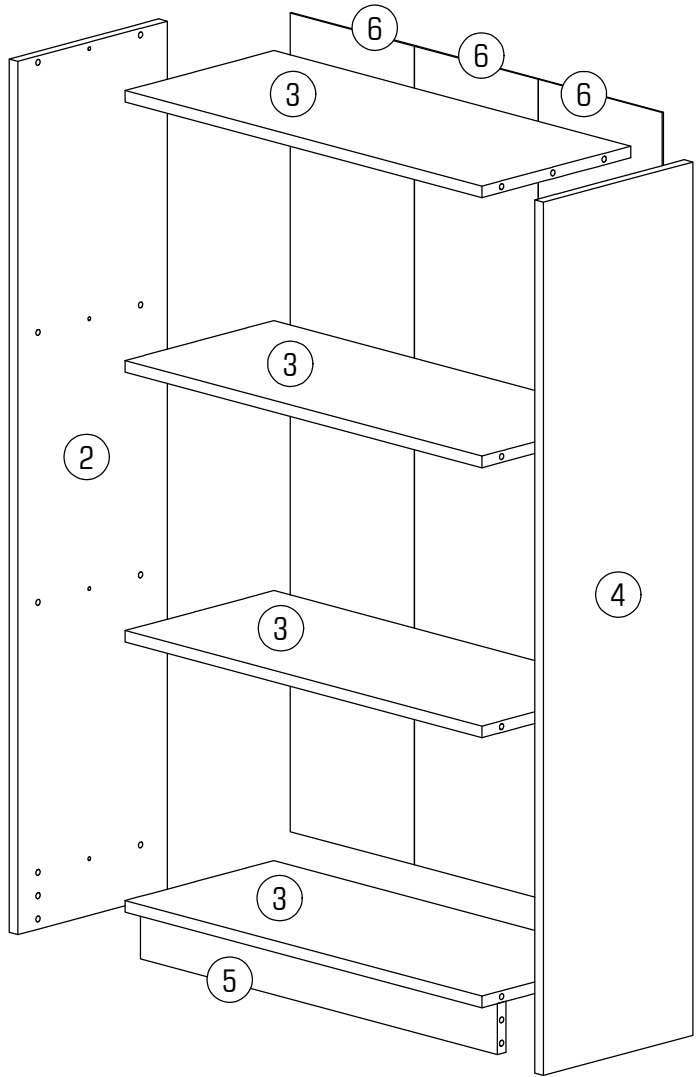

ID	ID			
21383	②	1200*280*16	1x	1/1
21393	③	668*279*16	4x	
21385	④	1200*280*16	1x	1/1
21394	⑤	668*70*16	1x	
21395	⑥	1125*232*3	3x	

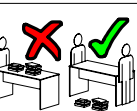
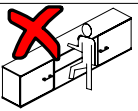
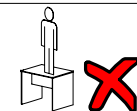
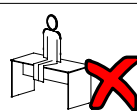
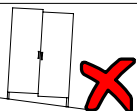
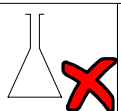

A	B	C	D	F	G	
6x	1x	25x	2x	1x	4x	
H	K	L	M	N	P	
1x	8x	8x	20x	6x	6x	

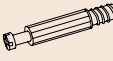

# 2/4 VIKI TYP2

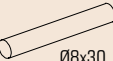

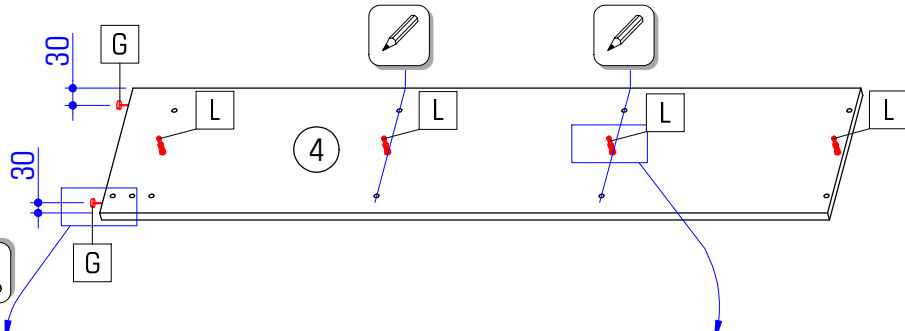
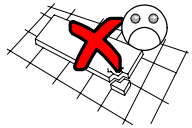
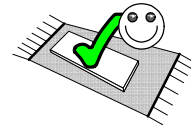
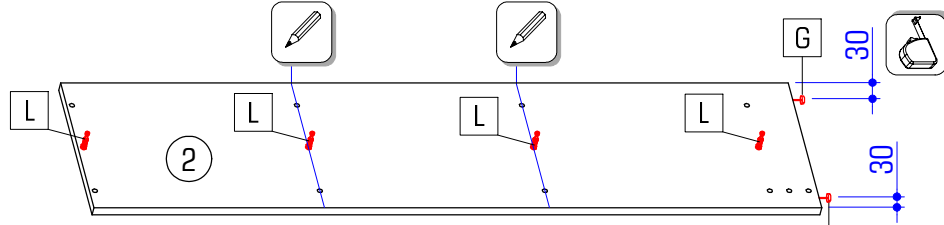
			
G 4x	L 8x	K 8x	M 20x

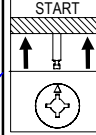
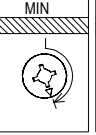
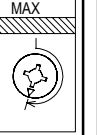
START	MIN	MAX
		

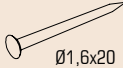
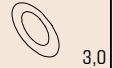
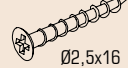
		
Ø1,6x20	3,0	Ø2,5x16
C 25x	N 6x	P 6x

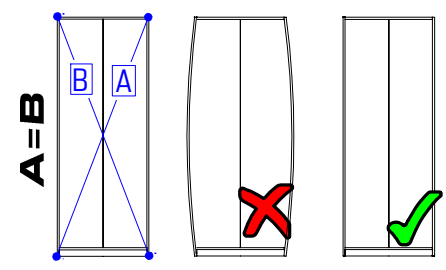
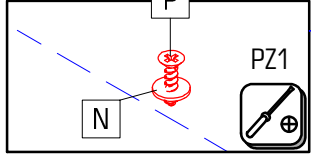
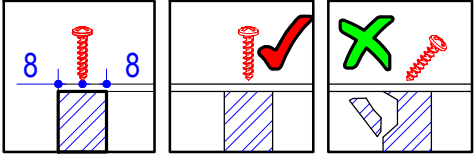
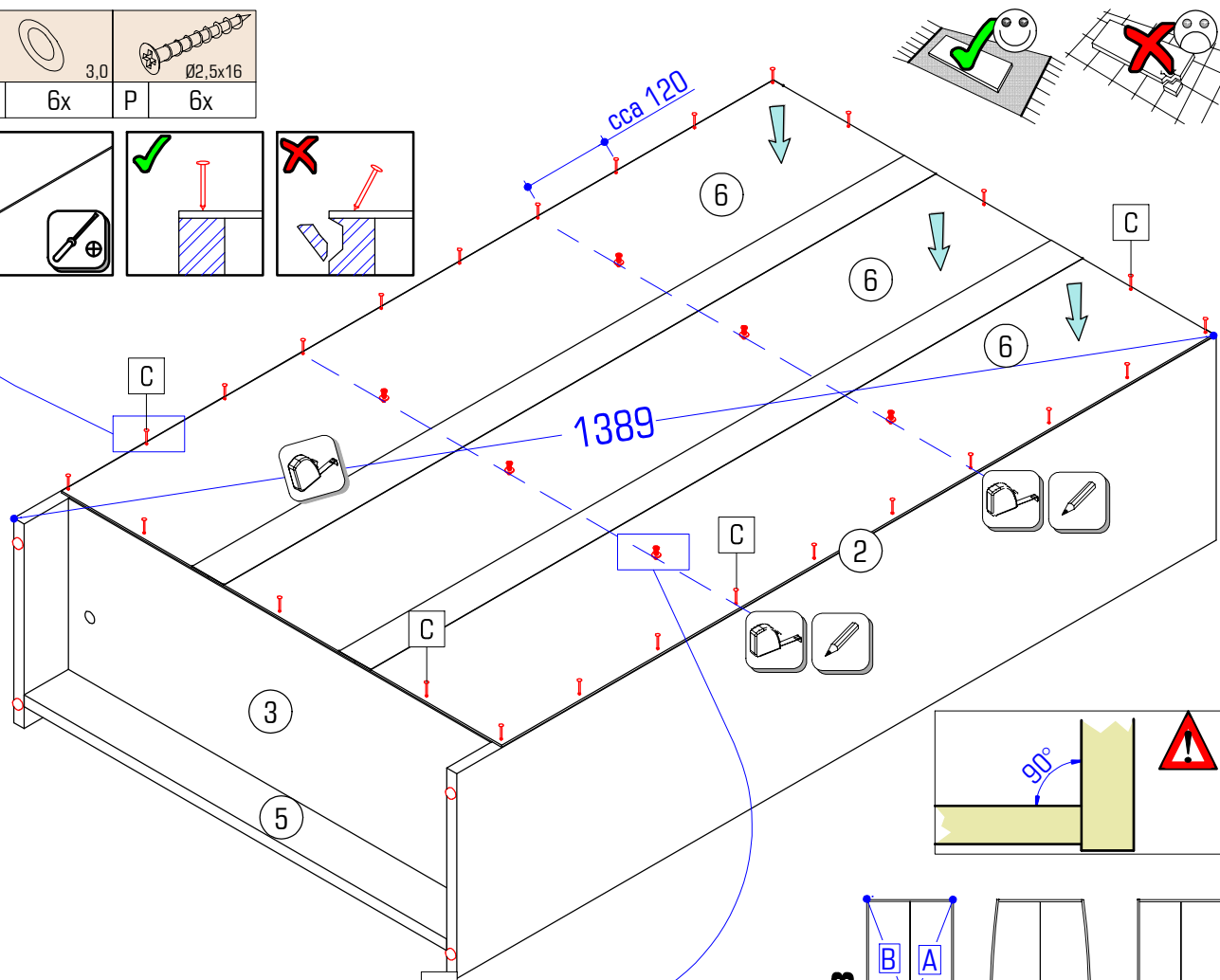
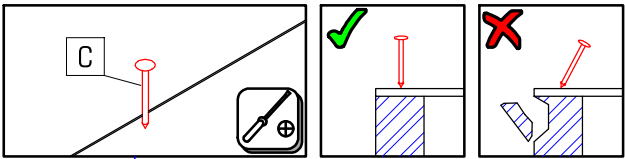

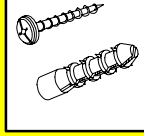
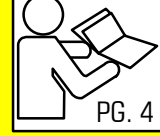
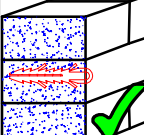
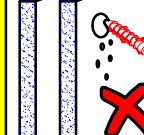
PG. 4

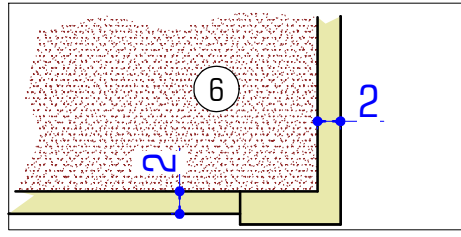

**PL** Uwaga! Ścianę należy sprawdzić przed montażem. Dołączone uniwersalne kolki rozporowe są odpowiednie tylko do stosowania w mocnych murach, takich jak beton lub cegła. Nie rób za pomocą kółków oporowych murowanych, takich jak pustak, lekka kostka, powierzchnie takie jak płyty gipsowo-kartonowe lub inne systemy ram. Jeśli dotyczy, muszą to być określone kolki rozporowe być użytych! Są one dostępne w specjalistycznym sklepie niezgodność producent / sprzedawca lub importer nie ponoszą odpowiedzialności.

**RO** Prudență! Zidul trebuie examinat înainte de asamblare prizele de perete sunt adecvate numai pentru utilizarea în zidurile fermă, cum ar fi betonul bloc sau cărămidă. Nu folosiți zidăria zidurilor de perete, cum ar fi cărămida goală, blocul ușor, suprafețe cum ar fi gips-carton sau altă încadrare sisteme. Dacă este cazul, trebuie folosite anumite prize de perete! Acestea sunt disponibile la un magazin specializat (magazin de hardware) . În caz de nerespectare, producătorul / vânzătorul cu amănuntul sau importatorul nu își asumă răspunderea.

**SI** Pozor! Pred montažo preverite stanje stene. Priloženi univerzalni mozniki so izključno samo za uporabo na čvrstem zidovju, kot sta beton in opeka. Stenski mozniki se ne smejo uporabljati pri zidovju kot so votlina opeke, zidaki za lahko gradnjo, mavčne plošče ali druge okvirne gradnje. Pri teh zidovjih morate v danih primerih uporabljati posebne moznike. Ti so na voljo v specializiranih trgovinah (trgovinah z gradbenim materialom) Pri upoštevanju se s strani proizvajalca/trgovca in uvoznika ne prevzame jamstvo.

**DE** Achtung! Die Wandbeschaffenheit ist vor der Montage unbedingt zu prüfen. Die beigelegten Universaldübel sind ausschließlich für festes Mauerwerk wie Beton/Ziegel. Die Mauerdübel dürfen nicht bei Mauerwerk wie Hohlraumziegel, Leichtbausteinen, Gipskartonplatte oder anderer Rahmenbauweise verwendet werden. Bei diesen Mauerwerken sind gegebenenfalls Spezialdübel zu verwenden! Diese sind in einem Fachgeschäft erhältlich. Bei Nichterhaltung wird seitens Produzenten/Händler und Importeur keine Haftung übernommen.

**HR** Pažnja! Prije montaže obvezno proverite svojstvo zida. Priložene univerzalne tiplje namijenjene su isključivo za masivne zidove od betona/opeke. Tiplje za masivne zidove ne smiju se koristiti za zidove kao npr šupljina opeka laki sastavni elementi, gips-kartonske ploče ili drugi modularni načini gradnje. Za te zidove potrebne su eventualno specijalne tiplje! Iste su dostupne u specializiranim trgovinama građevinskim materijalom. U slučaju nepridržavanja prethodno navedenih napomena, proizvođač/trgovac i uvoznik ne preuzimaju odgovornost!





**HU** Vigyázat! Szerelés előtt a falfelületet feltétlenül vizsgálja meg. A mellékelt univerzális tiplje kizárólag stabil falazathoz használható mint például beton/tégla. A fali tiplje nem használható könnyű építőkövekhez, üreg tégla, gipszkarton lapokhoz vagy más fávázás építményekhez. Ezekhez a falfelületekhez csak speciális tiplik használhatóak, melyek szaküzletekben (barkácsáruházakban) beszerezhetőek. Fentiek figyelmen kívül hagyása esetén a gyártó/kereskedő vagy forgalmazó nem vállal felelősséget.

**EN** Caution! The wall must be examined before assembly. The included universal wall plugs are only suitable for using in firm masonry such as concrete block or brick. Do not using the wall plugs masonry such as hollow brick, lightweight block, surfaces such as gypsum plasterboard or other framing systems. If applicable, particular wall plugs must be used! These are available at a specialised store (hardware store). In case of non-compliance, the manufacturer/retailer or importer do not assume liability.

**CZ** Upozornění! Před montáží je nutné zkontrolovat stav stěny. Přiložené univerzální hmoždinky jsou určeny pouze k použití pro pevné zdivo jako beton/cihly. Hmoždinky do zdi se nesmí používat u dutinová cihla, zdiva jako porývitý stavební kámen, sádrokartónová deska nebo jiný měkký materiál. U těchto zdiv jsou nutné použít speciální hmoždinky! Jsou k dostání v specializovaných prodejních stavebním materiálem. Při nedodržení těchto pokynů výrobce/prodejce a dovozce neručí za způsobené škody.

**SK** Upozornenie! Pevnosť steny sa musí pred montážou bezpodmienečne skontrolovať. Priložené univerzálne hmoždenky používajte jedine pre pevné murovo ako je betón/tehla. Hmoždenky sa nesmú používať v prípade ľahkého stavebného muriva, dutá tehla, Sádrokartónová doska, alebo iných konštrukcii rámu. U týchto stien je nutné použiť špeciálne hmoždenky! Tieto je možné dostať v špecializovaných predajniach so stavebným materiálom. Pri nedodržaní pokynov nepreberajú výrobcovia/predajci a dodávateľa zodpovednosť za vzniknuté škody.

# 4/4 VIKI TYP2

				
A 6x	B 1x	D 2x	F 1x	H 1x

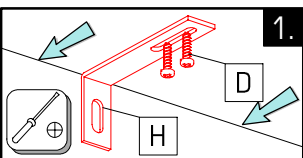

1.

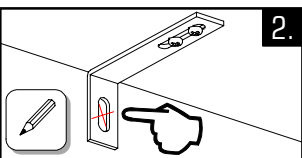

2.

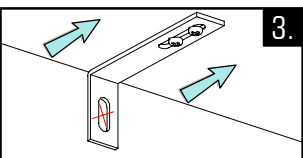

3.

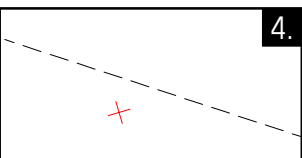

4.

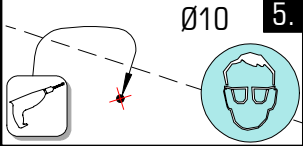

5. Ø10

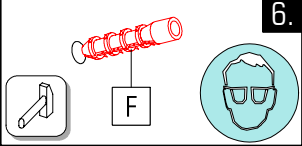

6.

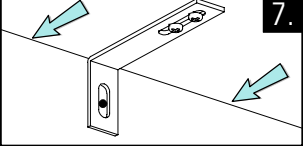

7.

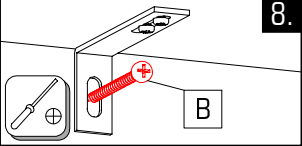

8.

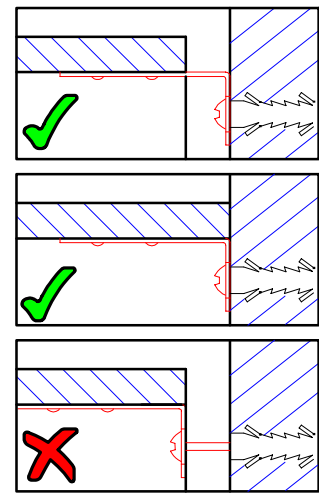
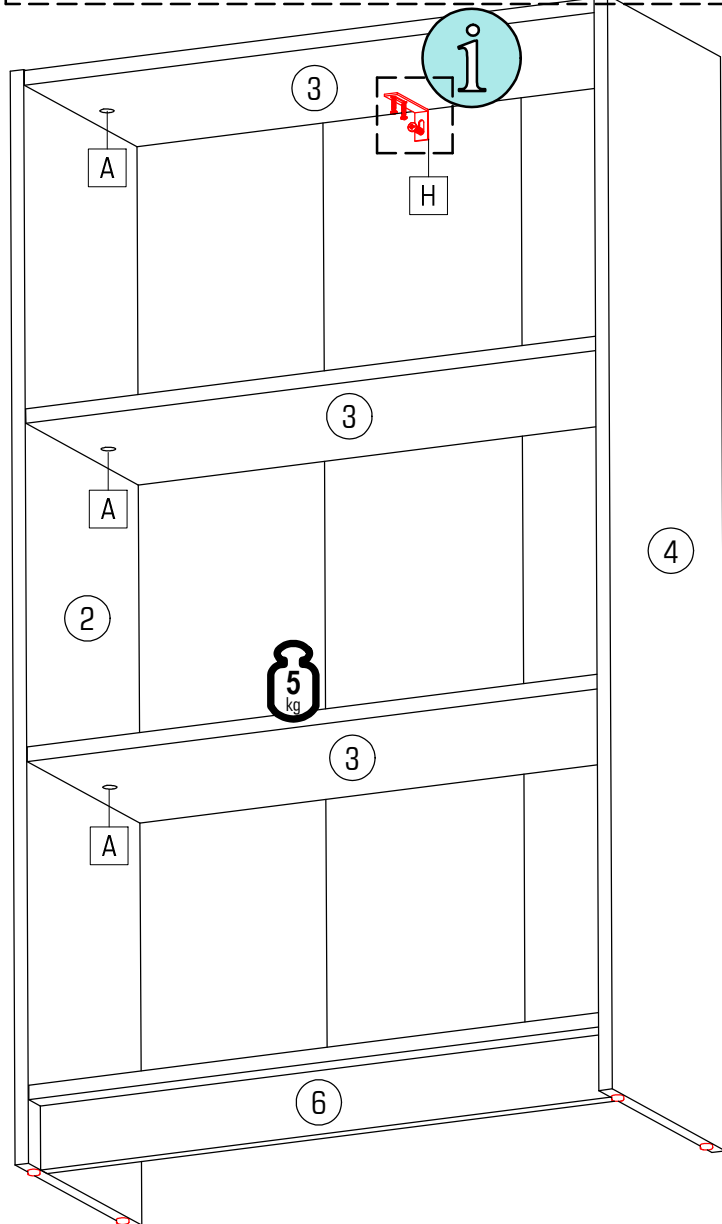

SK	VÝSTRAHA
CZ	VAROVÁNÍ
HR	UPOZORENIE
DE	WARNUNG
HU	FIGYELEM
PL	OSTRZEŻENIE
RO	AVERTIZARE
EN	WARNING
SI	OPOZORILO

